

AD100

Whats Included

- Cement/clay oven
- Flue
- Steel slab base (preassembled only)
- Steel sub floor
- 1 Pizza paddle
- Refractory brick floor
- 1 Recipe book
- 1 Powder coated oven door
- 1 oven stand (preassembled only)
- Assembly instructions (DIY only)

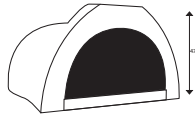

Oven Dimensions

External dimensions of oven

Length (front to back)	1400mm
Width (left to right)	1300mm
Oven height (excluding flue)	780mm
Weight (preassembled)	1000kg
Weight (DIY)	440kg

Internal dimensions of oven

Length (front to back)	1250mm
Width (left to right)	1015mm

Flue details

Flue height	1000mm
Flue diameter	275mm



Delivery Quantity

Preassembled oven

20ft container load	8 units
40HQ container load	16 units

DIY kit

20ft container load	20 units
40HQ container load	40 units

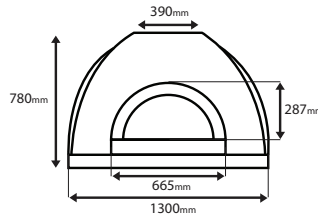

Oven Diagram (Front)

Width	1300mm
Height	780mm
Arch width	665mm
Arch height	287mm
Flue base width	390mm



Weight
1000kg Preassembled
440kg DIY

Preassembled only

Slab Size

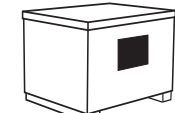
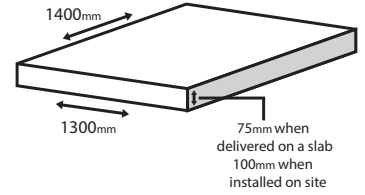

Box Dimensions

Preassembled oven

(L) 1400mm x (W) 1540mm x (H) 1080mm

DIY kit

(L) 1110mm x (W) 1170mm x (H) 1025mm

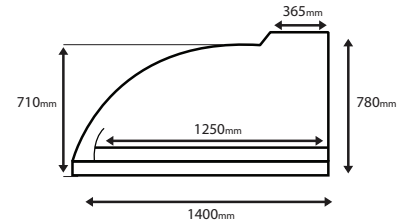

Oven Diagram (Side)

Length	1400mm
Height	780mm
Internal length	1250mm
Flue base width	365mm
Rear height	710mm

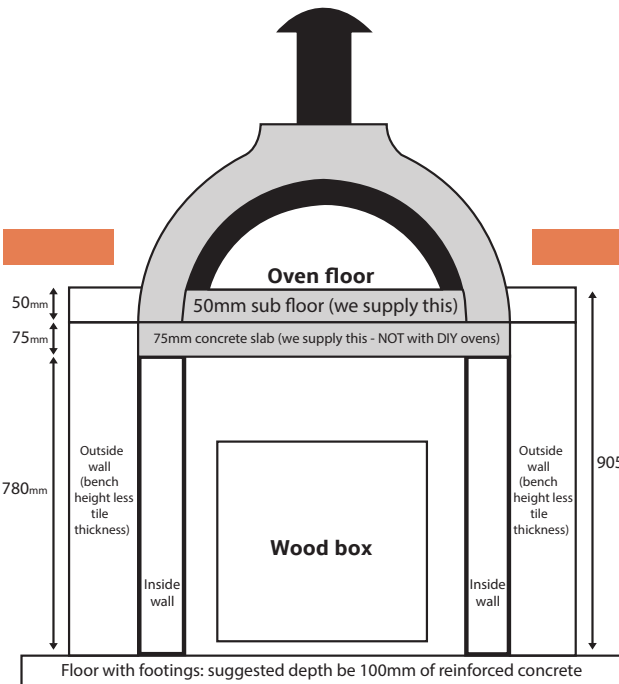

Oven sub floor	50mm
Slab	75mm
Sub floor and slab	125mm
Bench height	905mm +/-
Supporting wall for oven	780mm +/-
Oven floor height on supporting wall	905mm +/-

Note: Exterior wall height to suit tile and granite thickness to match oven floor height.

Suggested base sizes (plain base)

Length (including prep area)	1650mm
Front prep area	250mm
Width (suggested minimum)	1500mm
Width (with side prep area)	1800mm

Wood box (suggested)
600mm x 60mm x 800mm deep
(bench height)
905mm to 950mm

Suggested base sizes (corner base)

Sides (absolute minimum)	1800mm
Sides (good)	1850mm
Sides (recommended)	1900mm
Width of wall	950mm
Front prep area (widest point)	250mm

Wood box (suggested)
600mm x 60mm x 800mm deep
Height (bench height)
850mm to 950mm
Distance from back corner
to front of oven floor
1730mm

Plain Base

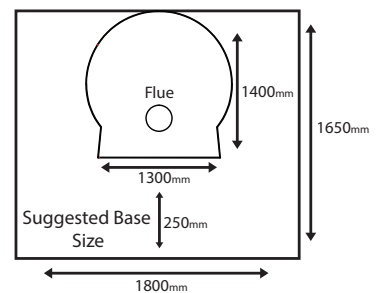

Corner base

