

# AD110

## Whats Included

- Cement/clay oven
- Flue
- Steel slab base (preassembled only)
- Steel sub floor
- 1 Pizza paddle
- Refractory brick floor
- 1 Recipe book
- 1 Powder coated oven door
- 1 oven stand (preassembled only)
- Assembly instructions (DIY only)

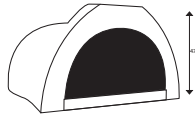

Oven Dimensions

### External dimensions of oven

Length (front to back)	1500mm
Width (left to right)	1400mm
Oven height (excluding flue)	780mm
Weight (preassembled)	1200kg
Weight (DIY)	510kg

### Internal dimensions of oven

Length (front to back)	1330mm
Width (left to right)	1112mm

### Flue details

Flue height	1000mm
Flue diameter	275mm



Delivery Quantity

### Preassembled oven

20ft container load	6 units
40HQ container load	14 units

### DIY kit

20ft container load	20 units
40HQ container load	40 units

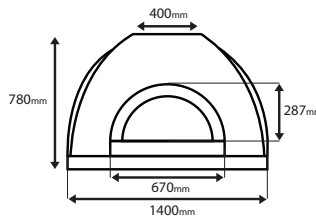

### Oven Diagram (Front)

Width	1400mm
Height	780mm
Arch width	670mm
Arch height	287mm
Flue base width	400mm



### Weight

1200kg Preassembled  
510kg DIY

Preassembled only

### Slab Size

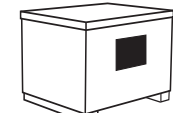
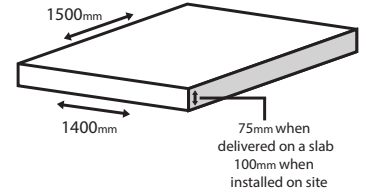

Box Dimensions

### Preassembled oven

(L) 1550mm x (W) 1650mm x (H) 1080mm

### DIY kit

(L) 1110mm x (W) 1170mm x (H) 1025mm

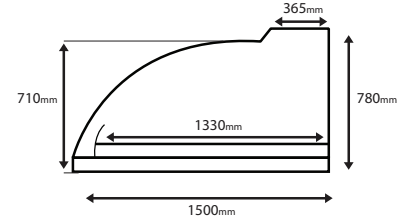

### Oven Diagram (Side)

Length	1500mm
Height	780mm
Internal length	1330mm
Flue base width	365mm
Rear height	710mm

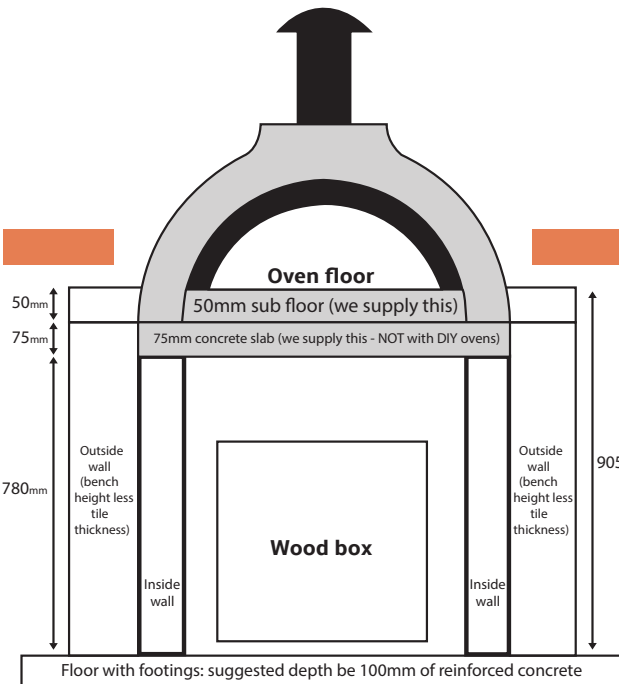

Oven sub floor	50mm
Slab	75mm
Sub floor and slab	125mm
Bench height	905mm +/-
Supporting wall for oven	780mm +/-
Oven floor height on supporting wall	905mm +/-

**Note:** Exterior wall height to suit tile and granite thickness to match oven floor height.

### Suggested base sizes (plain base)

Length (including prep area)	1750mm
Front prep area	250mm
Width (suggested minimum)	1600mm
Width (with side prep area)	1900mm

Wood box (suggested)  
600mm x 60mm x 800mm deep  
Height (bench height)  
905mm to 950mm

### Suggested base sizes (corner base)

Sides (absolute minimum)	1900mm
Sides (good)	1950mm
Sides (recommended)	2000mm
Width of wall	1000mm
Front prep area (widest point)	250mm

Wood box (suggested)  
600mm x 60mm x 800mm deep  
Height (bench height)  
850mm to 950mm  
Distance from back corner  
to front of oven floor

1830mm

### Plain Base

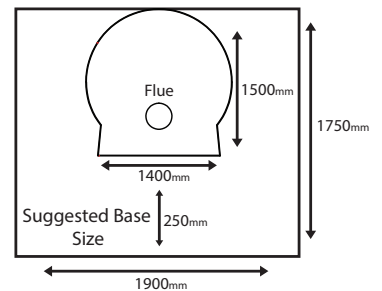

### Corner base

