

Entertainer



Weight
1100kg Preassembled
550kg DIY

Whats Included

- Cement/clay oven
- Flue
- Steel slab base (preassembled only)
- Steel sub floor
- 1 Pizza paddle
- Refractory brick floor
- 1 Recipe book
- 1 Powder coated oven door
- 1 oven stand (preassembled only)
- Assembly instructions (DIY only)



Preassembled only

Slab Size

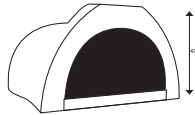
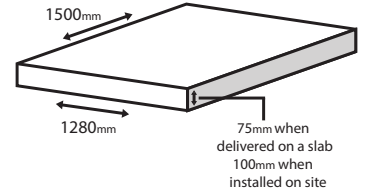

Oven Dimensions



Delivery Quantity

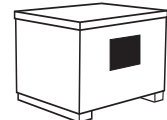

Box Dimensions

External dimensions of oven

Length (front to back)	1500mm
Width (left to right)	1280mm
Oven height (excluding flue)	770mm
Weight (preassembled)	1100kg
Weight (DIY)	550kg

Internal dimensions of oven

Length (front to back)	1320mm
Width (left to right)	900mm

Flue details

Flue height	1000mm
Flue diameter	275mm

Preassembled oven

20ft container load	8 units
40HQ container load	16 units

DIY kit

20ft container load	16 units
40HQ container load	36 units

Preassembled oven

(L) 1430mm x (W) 1650mm x (H) 1050mm

DIY kit

(L) 1285mm x (W) 1165mm x (H) 885mm

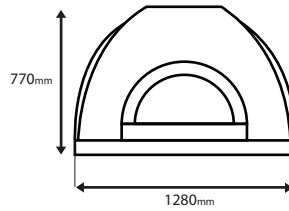

Oven Diagram (Front)

Width	1280mm
Height	770mm

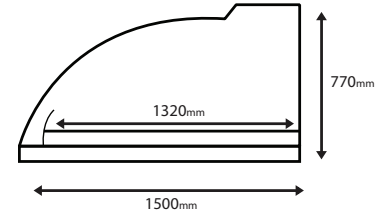

Oven Diagram (Side)

Length	1500mm
Height	770mm
Internal length	1320mm

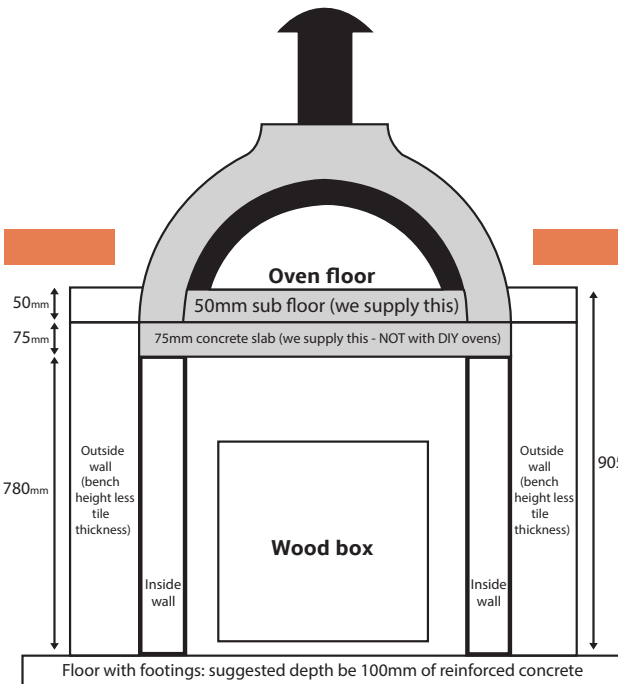

Oven sub floor	50mm
Slab	75mm
Sub floor and slab	125mm
Bench height	905mm +/-
Supporting wall for oven	780mm +/-
Oven floor height on supporting wall	905mm +/-

Note: Exterior wall height to suit tile and granite thickness to match oven floor height.

Suggested base sizes (plain base)

Length (including prep area)	1750mm
Front prep area	250mm
Width (suggested minimum)	1480mm
Width (with side prep area)	1780mm

Wood box (suggested)
600mm x 60mm x 800mm deep
Height (bench height)
905mm to 950mm

Suggested base sizes (corner base)

Sides (absolute minimum)	1900mm
Sides (good)	1950mm
Sides (recommended)	2000mm
Width of wall	1000mm
Front prep area (widest point)	250mm

Wood box (suggested)
600mm x 60mm x 800mm deep
Height (bench height)
850mm to 950mm
Distance from back corner
to front of oven floor
1830mm

Plain Base

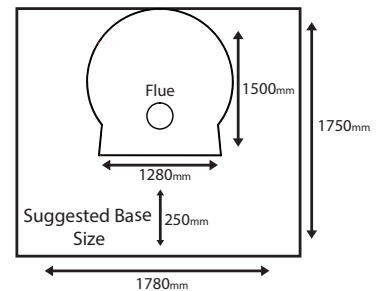

Corner base

