

# Family

## Whats Included

- Cement/clay oven
- Flue
- Steel slab base (preassembled only)
- Steel sub floor
- 1 Pizza paddle
- Refractory brick floor
- 1 Recipe book
- 1 Powder coated oven door
- 1 oven stand (preassembled only)
- Assembly instructions (DIY only)



**Weight**  
570kg Preassembled  
260kg DIY

Preassembled only

## Slab Size

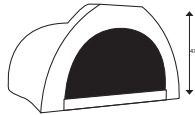
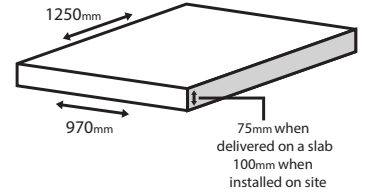

Oven Dimensions



Delivery Quantity

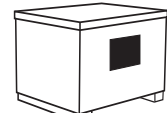

Box Dimensions

## External dimensions of oven

Length (front to back)	1250mm
Width (left to right)	970mm
Oven height (excluding flue)	620mm
Weight (preassembled)	570kg
Weight (DIY)	260kg

## Internal dimensions of oven

Length (front to back)	1056mm
Width (left to right)	664mm

## Flue details

Flue height	1000mm
Flue diameter	275mm

## Preassembled oven

20ft container load	16 units
40HQ container load	32 units

## DIY kit

20ft container load	24 units
40HQ container load	68 units

## Preassembled oven

(L) 1415mm x (W) 1090mm x (H) 860mm

## DIY kit

(L) 1250mm x (W) 970mm x (H) 580mm

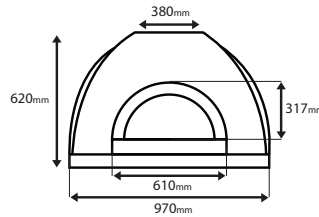

## Oven Diagram (Front)

Width	970mm
Height	620mm
Arch width	610mm
Arch height	317mm
Flue base width	380mm

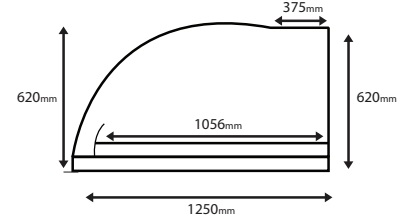

## Oven Diagram (Side)

Length	1250mm
Height	620mm
Internal length	1056mm
Flue base width	375mm
Rear height	620mm

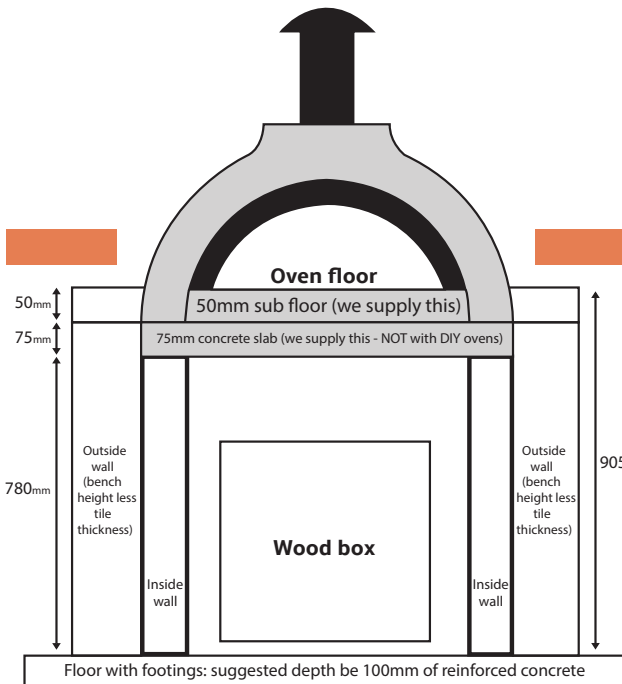

Oven sub floor	50mm
Slab	75mm
Sub floor and slab	125mm
Bench height	905mm +/-
Supporting wall for oven	780mm +/-
Oven floor height on supporting wall	905mm +/-

**Note:** Exterior wall height to suit tile and granite thickness to match oven floor height.

## Suggested base sizes (plain base)

Length (including prep area)	1500mm
Front prep area	250mm
Width (suggested minimum)	1170mm
Width (with side prep area)	1470mm

Wood box (suggested)  
600mm x 60mm x 800mm deep  
Height (bench height)  
905mm to 950mm

## Suggested base sizes (corner base)

Sides (absolute minimum)	1500mm
Sides (good)	1550mm
Sides (recommended)	1600mm
Width of wall	850mm
Front prep area (widest point)	250mm

Wood box (suggested)  
600mm x 60mm x 800mm deep  
Height (bench height)  
850mm to 950mm  
Distance from back corner  
to front of oven floor

1470mm

## Plain Base

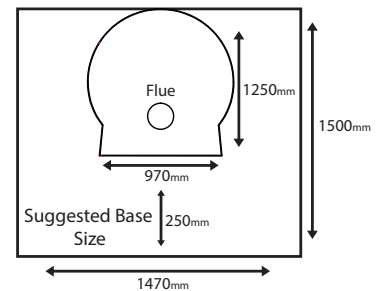

## Corner base

